

Risba je lasti Energy Save AB. Vsaka zloraba te risbe, razmnoževanje, prodaja tretji osebi ali uporaba v drugačne namene kot je bilo dogovorjeno, je prepovedana!

Diese Zeichnung ist Eigentum der Energy Save AB. Jegliche nichtbeabsichtigte oder unzulässige Kopie, Verbreitung oder Benutzung der Zeichnung für andere als die vorgesehenen Zwecke ist streng verboten!

This drawing is the property of Energy Save AB, and must not, without our consent be copied, handed to other persons or otherwise misused!

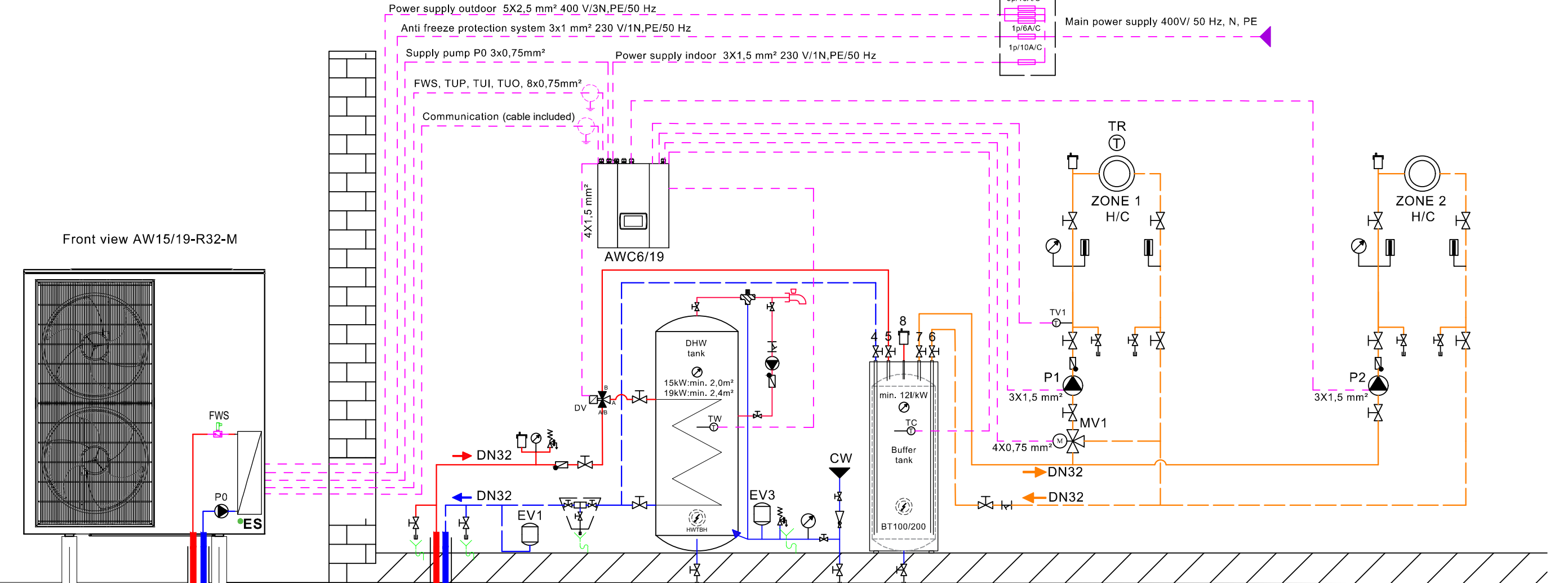
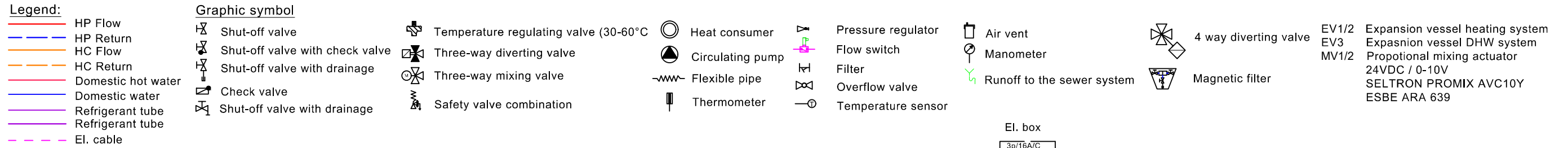

Front view AW15/19-R32-M

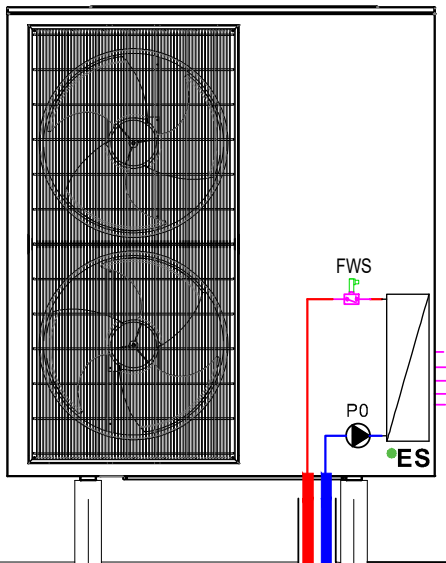

Side view AW15/19-R32-M

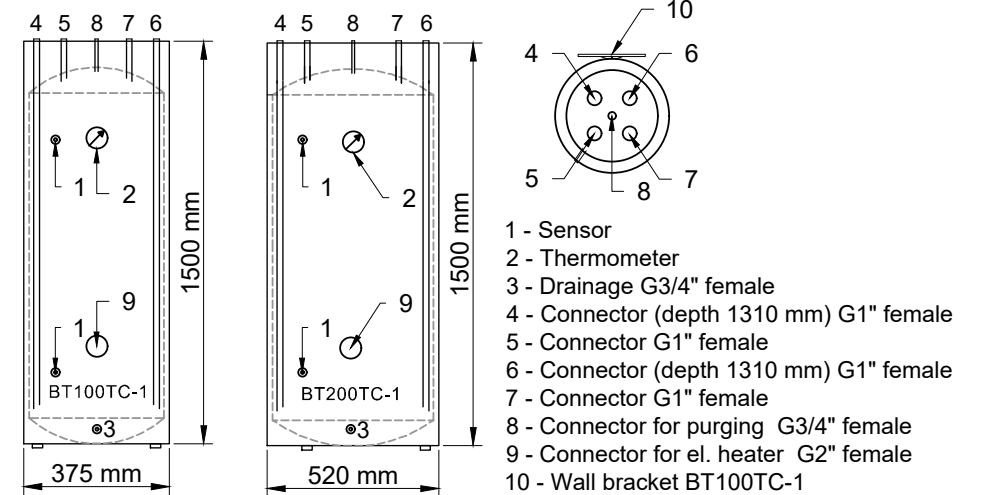
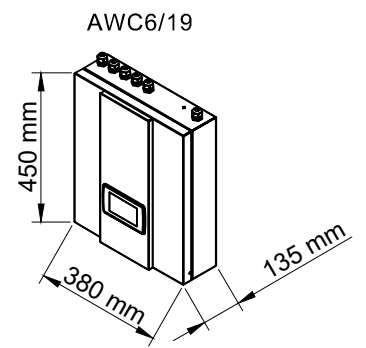
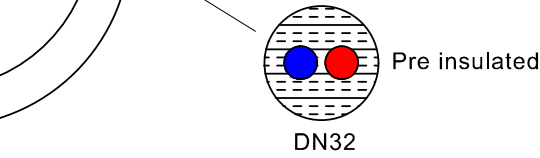
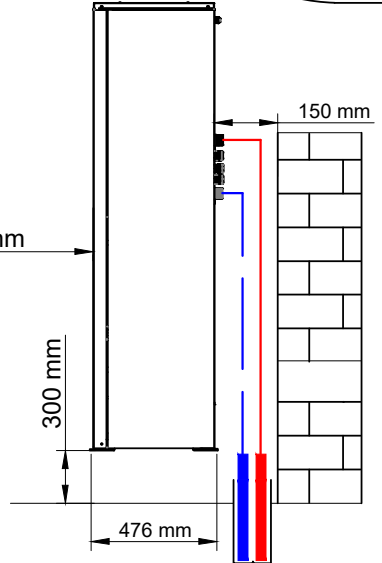

Classification of the Drawing/Klassifizierung/Klasifikacija risbe:		Date, Datum : 21.2.2020
	Title/Title: AWC15/19-R32-M, DHW tank, buffer BT100TC-1/200TC-1, 1 x mixing heating / cooling circuit, 1 direct heating/cooling circuit	Drawing ID/Zeichnungs ID/ Oznaka risbe: <b>Ver1</b>
	Naziv:	Revision/Prüfung/Revizija: MK